

THE PROPERTY OF THE DRAWING IS ESTABLISHED BY LAW. IT IS FORBIDDEN TO PRODUCE OR SHOW IT TO THIRD PART. WITHOUT A WRITTEN AGREEMENT.

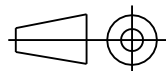
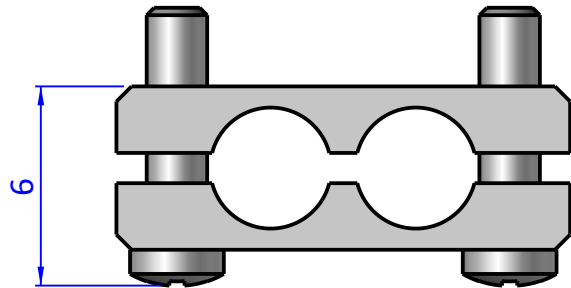
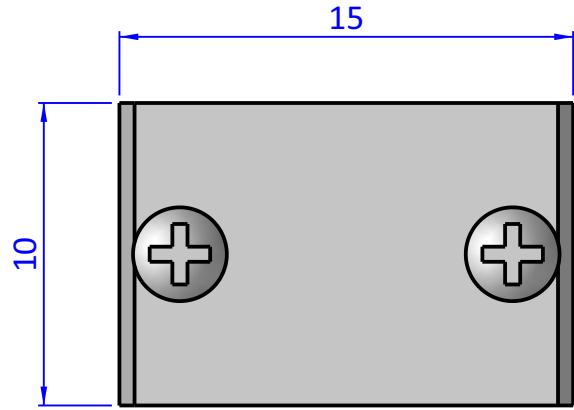
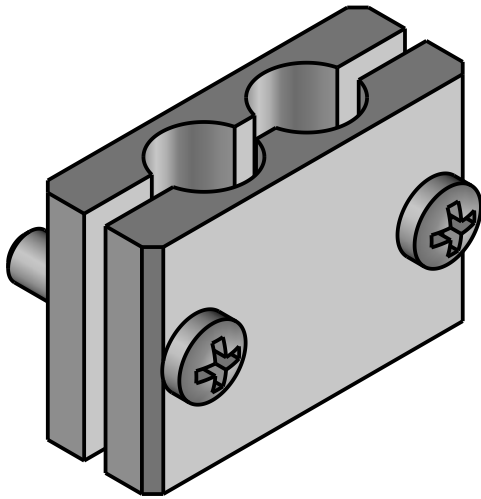

DESIGNED FROM

FPS Automation

REVIEW

A

DATE

01/04/2023

WEIGHT

-

CODE

CA.I.SGSP.32

Format A4

UNI 936-76

GENERAL TOLERANCE

UNI - ISO 2768

CLASSE f

DESCRIPTION

CA.I.SGSP.32